

**ESTONIAN
DEFENCE
WEEK**

TALLINN DEFENCE EXPO 2026

**Stand configuration and
customisation options
Version 1.0**

EVENT OVERVIEW & CONTACTS

Event Title: Estonian Defence Week 2026 – Tallinn Defence EXPO 2026
Event Dates: 22-24 September 2026
Event Venue: Tallinn Creative Hub (Kultuurikatel)
Website Link: www.edw.ee
Version: 1.0
Organised by: Estonian Defence and Aerospace Industry Association
www.defence.ee

Official Expo Vendor & Technical Partner:

Kingent Management
www.kingent.ee

Expo Manager & Primary Contact:

Merlyn Paomets
merlyn@kingent.ee
+372 5840 0583

General Inquiries & Backup:

expo@kingent.ee
+372 5557 5318

STANDS

STANDARD 1

- **Footprint:** 2.0 x 1.5 m
- **Height:** 2.5 m
- **Flooring:** Carpet with protective film
- **Power Supply:** 2 x Schuko sockets, 230 V, 16 A, 1.5 kW
- **Lighting:** LED ceiling lights, 300 lux, 4000 K
- **Exhibition counter:** 1.0 x 0.5 m, height 1.0 m
- **Seating:** 2 bar stools
- **Display:** 55" LCD screen with HDMI connection
- All areas marked in orange can be customised with your own graphics.

STANDARD 1

All areas marked in orange can be customised with your own graphics.

Iso view

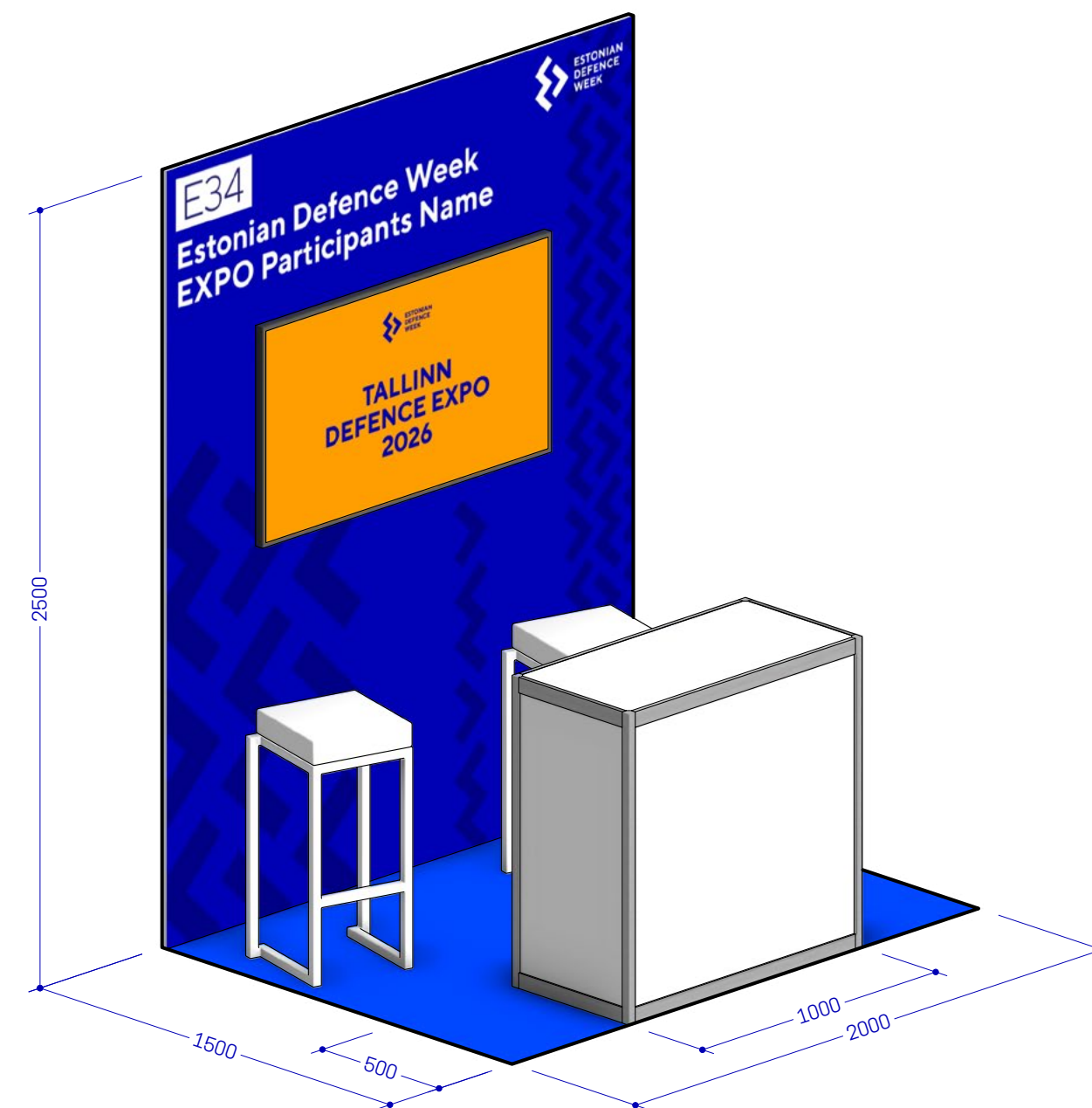

Front view



www.kingent.ee
A3 / M=1:20

STANDS

STANDARD 1 CUSTOM

- **Footprint:** 2.0 x 1.5 m
- **Height:** 2.5 m
- **Flooring:** Carpet with protective film
- **Power Supply:** 2 x Schuko sockets, 230 V, 16 A, 1.5 kW
- **Lighting:** LED ceiling lights, 300 lux, 4000 K
- **Exhibition counter:** 1.0 x 0.5 m, height 1.0 m
- **Seating:** 2 bar stools
- **Display:** 55" LCD screen with HDMI connection

Custom graphic design option

Exhibitors may customise designated stand areas (marked in orange) with their graphics. All designs must meet event standards and require approval by the Expo Manager for consistency.

Important:

The deadline for submitting graphic design files is 12 June 2026.

STANDARD 1 CUSTOM

All areas marked in orange can be customised with your own graphics.

Iso view

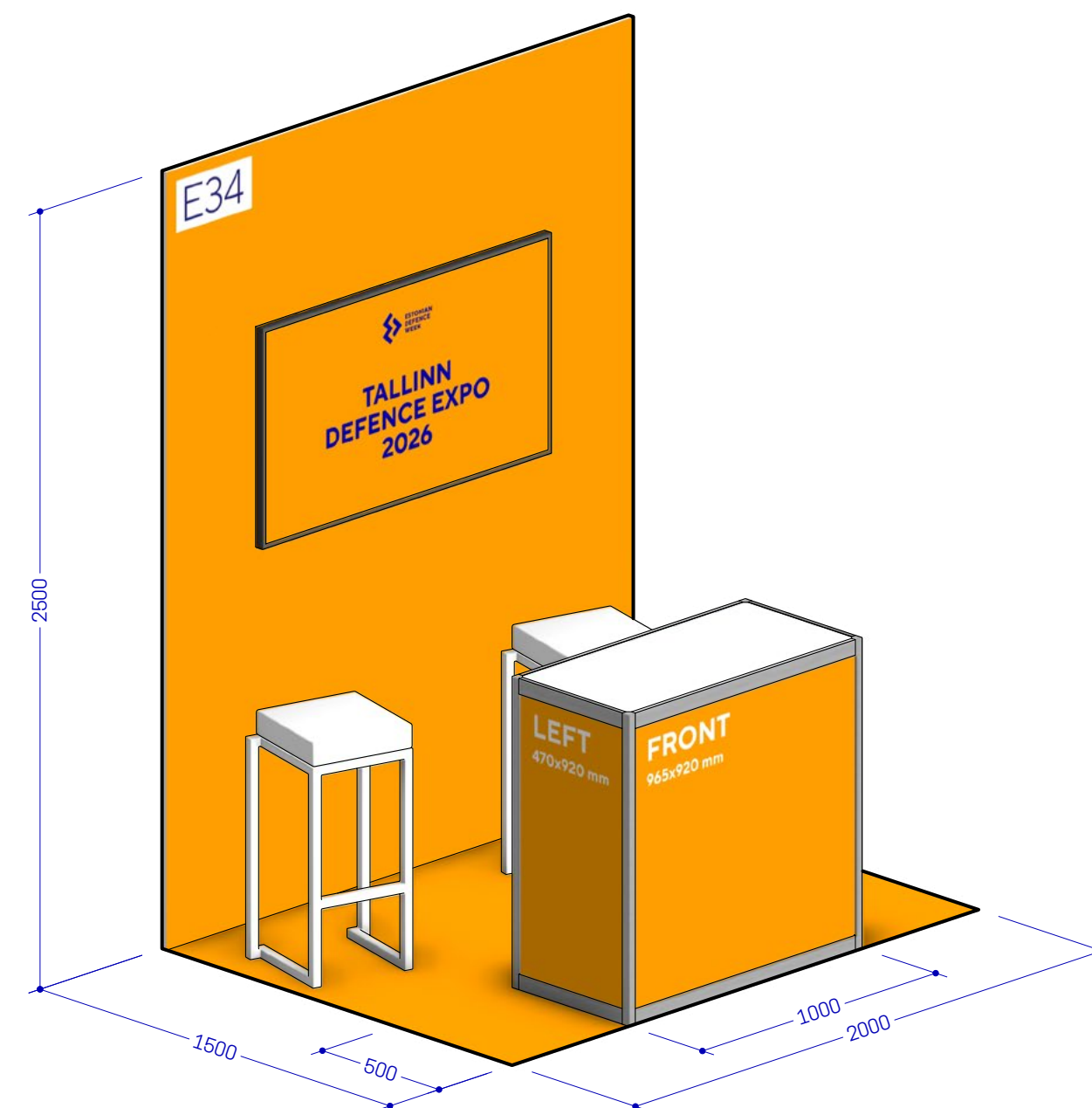

Front view

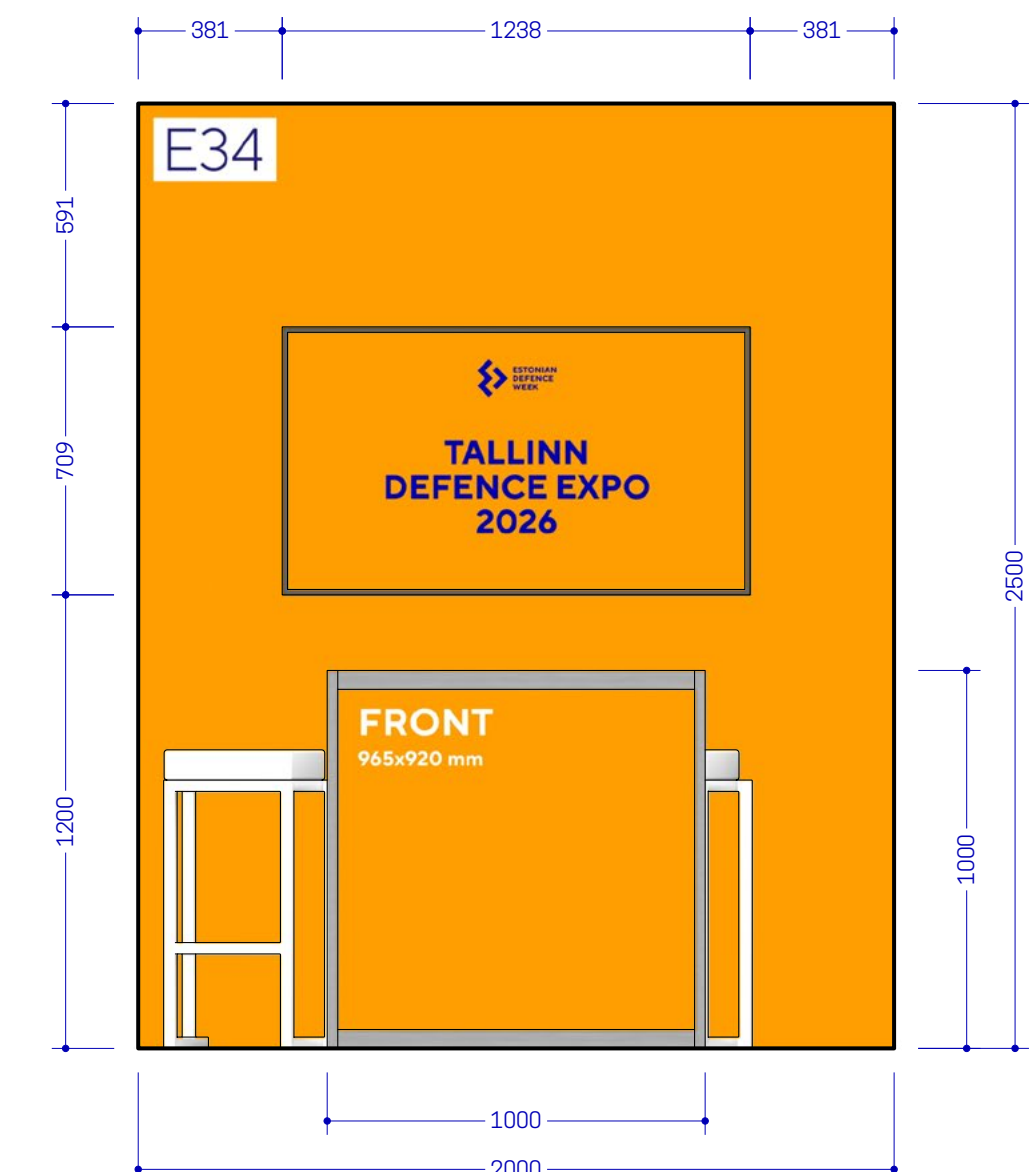

www.kingent.ee
A3 / M=1:20

STANDS

STANDARD 1 CUSTOM

STANDARD 1 CUSTOM

All areas marked in orange can be customised with your own graphics.

55" LCD



Resolution
3840 x 2160 (16:9)

Set Dimension (WxHxD)
1238 x 709 mm

Active Display Area
1209.6 x 680.4 mm

Stand back wall

NB! Keep area under stand number and LCD clear of logos and text.
Stand number sticker will be applied on-site.



Exhibition counter

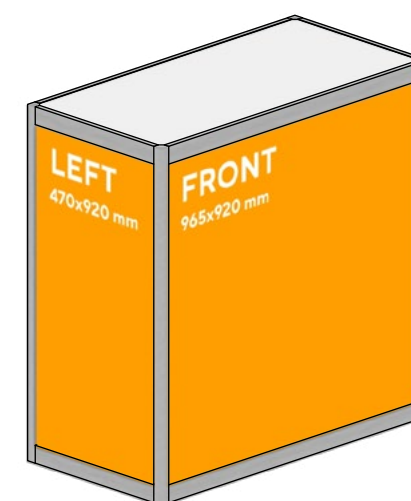

Important note:
All edges of the counter graphics will be inserted approximately 5-7 mm into grooves.
Avoid placing critical details or small text close to the edges.

www.kingent.ee
A3 / M=1:20

STANDS

STANDARD 2

- **Footprint:** 2.0 x 1.5 m
- **Height:** 2.3 m
- **Flooring:** Carpet with protective film
- **Power Supply:** 2 x Schuko sockets, 230 V, 16 A, 1.5 kW
- **Lighting:** LED ceiling lights, 300 lux, 4000 K
- **Exhibition counter:** 1.0 x 0.5 m, height 1.0 m
- **Seating:** 2 bar stools
- **Display:** 55" LCD screen with HDMI connection
- All areas marked in orange can be customised with your own graphics.

STANDARD 2

All areas marked in orange can be customised with your own graphics.

Iso view

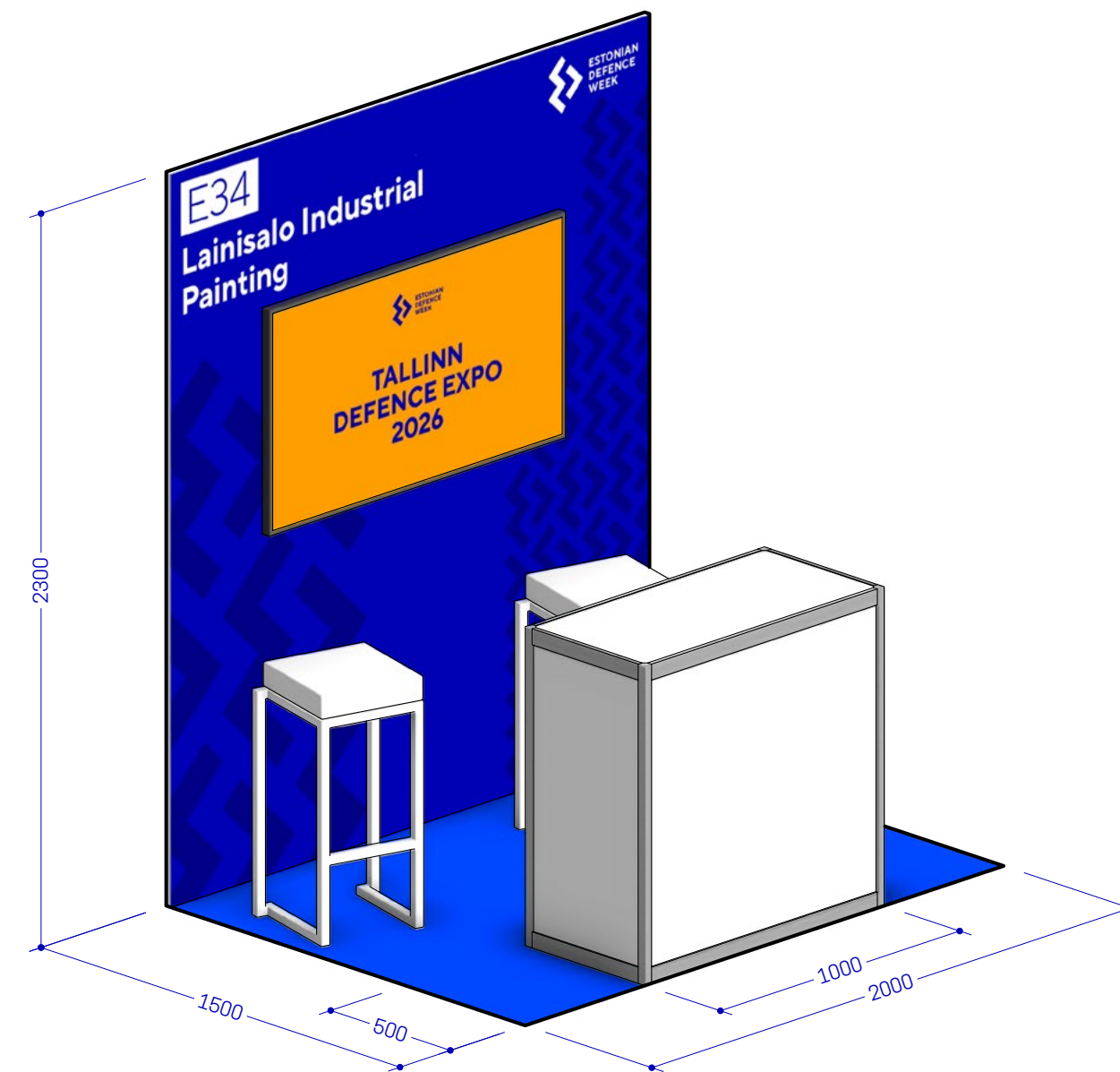

Front view



www.kingent.ee
A3 / M=1:20

STANDS

STANDARD 2 CUSTOM

- **Footprint:** 2.0 x 1.5 m
- **Height:** 2.3 m
- **Flooring:** Carpet with protective film
- **Power Supply:** 2 x Schuko sockets, 230 V, 16 A, 1.5 kW
- **Lighting:** LED ceiling lights, 300 lux, 4000 K
- **Exhibition counter:** 1.0 x 0.5 m, height 1.0 m
- **Seating:** 2 bar stools
- **Display:** 55" LCD screen with HDMI connection

Custom graphic design option

Exhibitors may customise designated stand areas (marked in orange) with their graphics. All designs must meet event standards and require approval by the Expo Manager for consistency.

Important:

The deadline for submitting graphic design files is 12 June 2026.

STANDARD 2 CUSTOM

All areas marked in orange can be customised with your own graphics.

Iso view

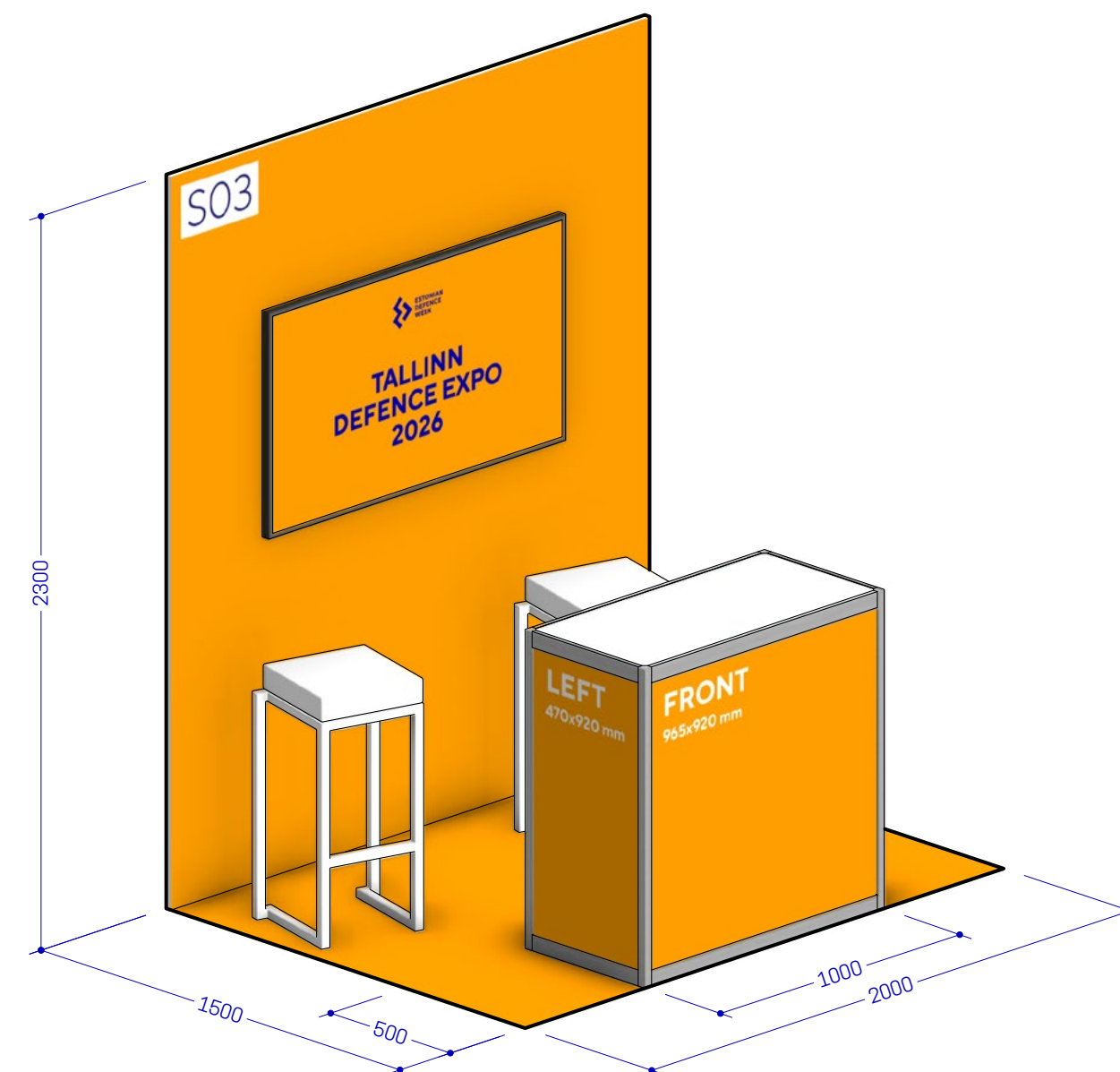

Front view



www.kingent.ee
A3 / M=1:20

STANDS

STANDARD 2 CUSTOM

STANDARD 2 CUSTOM

All areas marked in orange can be customised with your own graphics.

55" LCD



Resolution
3840 x 2160 (16:9)

Set Dimension (WxHxD)
1238 x 709 mm

Active Display Area
1209.6 x 680.4 mm

Stand back wall

NB! Keep area under stand number and LCD clear of logos and text.
Stand number sticker will be applied on-site.

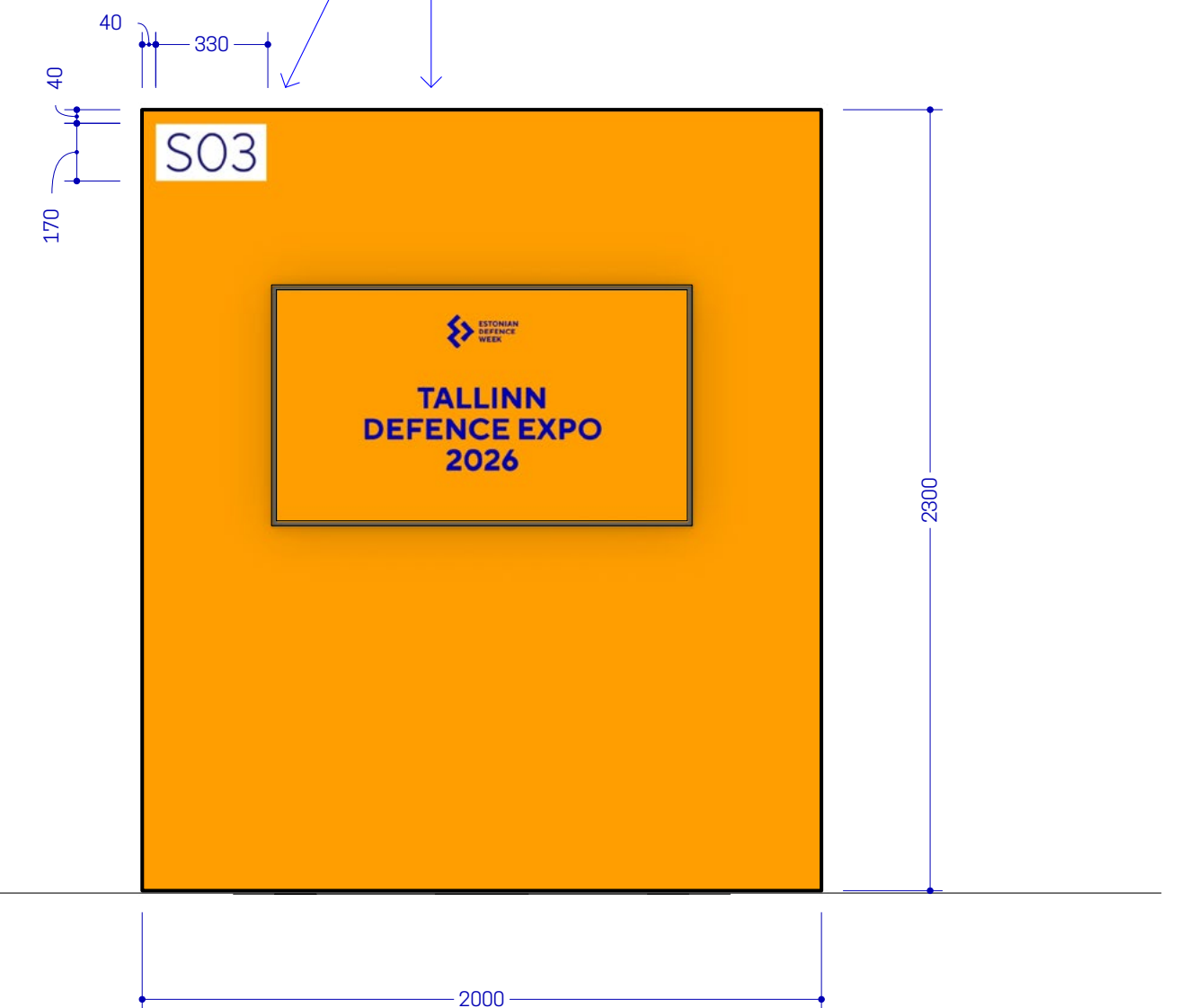

Exhibition counter

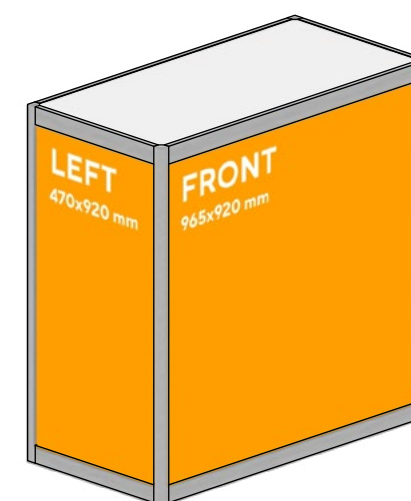

Important note:
All edges of the counter graphics will be inserted approximately 5-7 mm into grooves.
Avoid placing critical details or small text close to the edges.

www.kingent.ee
A3 / M=1:20

STANDS

STANDARD 1 DOUBLE

- **Footprint:** 4.0 x 1.5 m
- **Height:** 2.5 m
- **Flooring:** Carpet with protective film
- **Power Supply:** 2 x Schuko sockets, 230 V, 16 A, 1.5 kW
- **Lighting:** LED ceiling lights, 300 lux, 4000 K
- **Exhibition counter:** 2 counters (1.0 x 0.5 m, height 1.0 m)
- **Seating:** 4 bar stools
- **Display:** 2 x 55" LCD screen with HDMI connection
- All areas marked in orange can be customised with your own graphics.

STANDARD 1 DOUBLE

All areas marked in orange can be customised with your own graphics.

Iso view

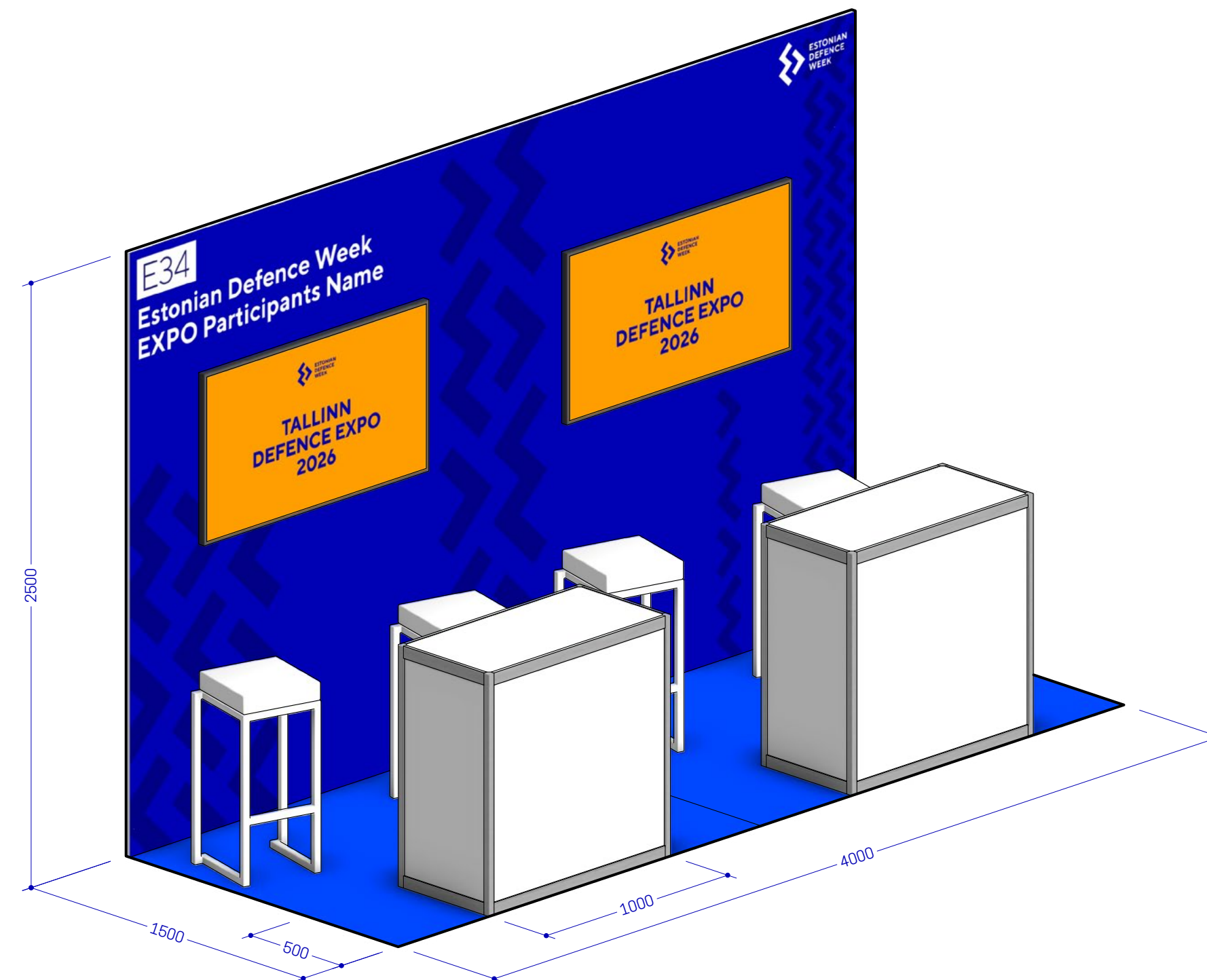

www.kingent.ee
A3/M=1:20

STANDS

STANDARD 1 DOUBLE

STANDARD 1 DOUBLE

All areas marked in orange can be customised with your own graphics.

Front view

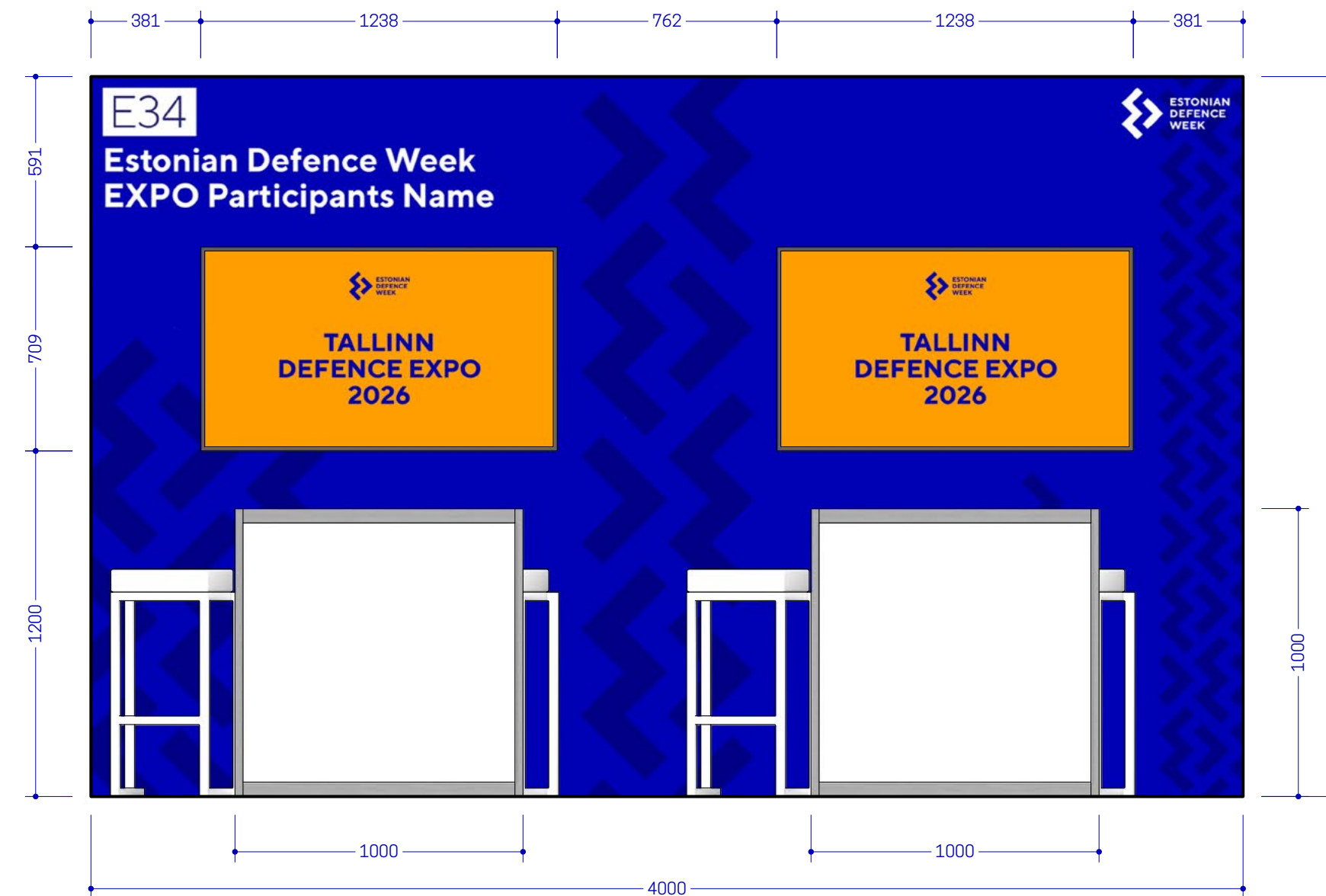

STANDS

STANDARD 1 CUSTOM DOUBLE

- **Footprint:** 4.0 x 1.5 m
- **Height:** 2.5 m
- **Flooring:** Carpet with protective film
- **Power Supply:** 4 x Schuko sockets, 230 V, 16 A, 1.5 kW
- **Lighting:** LED ceiling lights, 300 lux, 4000 K
- **Exhibition counter:** 2 counters (1.0 x 0.5 m, height 1.0 m)
- **Seating:** 4 bar stools
- **Display:** 2 x 55" LCD screen with HDMI connection

Custom graphic design option

Exhibitors may customise designated stand areas (marked in orange) with their graphics. All designs must meet event standards and require approval by the Expo Manager for consistency.

Important:

The deadline for submitting graphic design files is 12 June 2026.

STANDARD 1 CUSTOM DOUBLE

All areas marked in orange can be customised with your own graphics.

Iso view

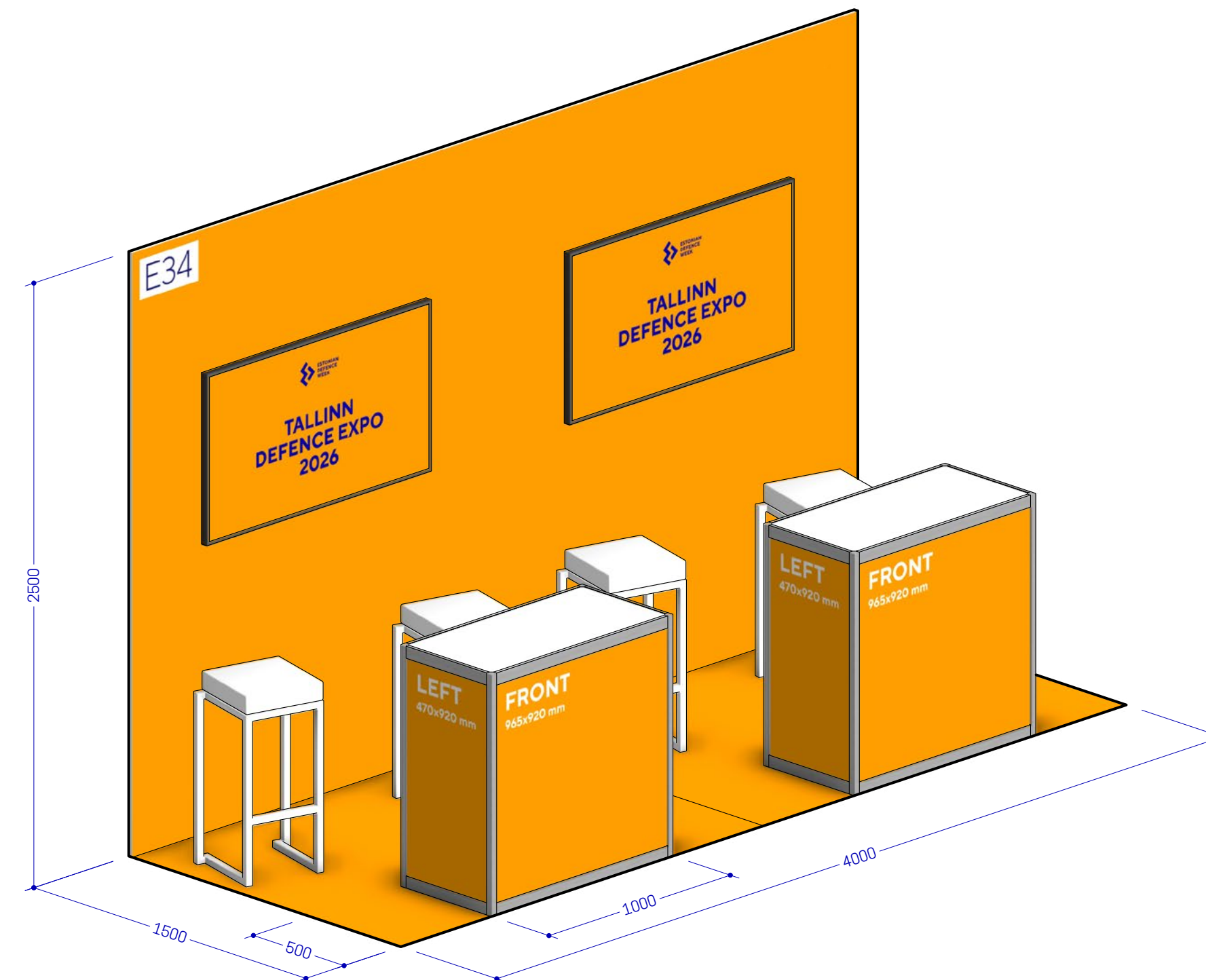

www.kingent.ee
A3/M=1:20

STANDS

STANDARD 1 CUSTOM DOUBLE

STANDARD 1 CUSTOM DOUBLE

All areas marked in orange can be customised with your own graphics.

Front view

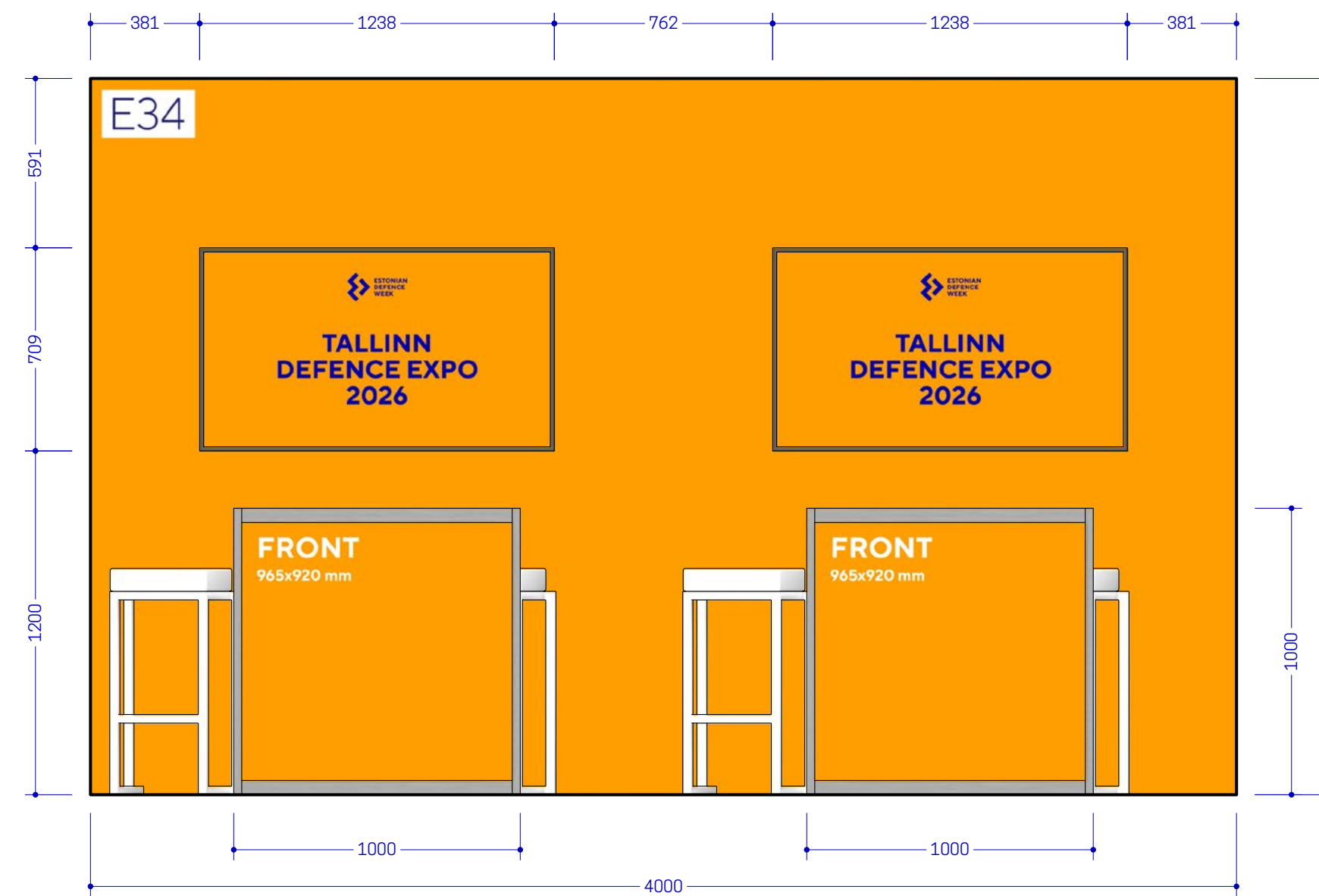

STANDS

STANDARD 1 CUSTOM DOUBLE

STANDARD 1 CUSTOM DOUBLE

All areas marked in orange can be customised with your own graphics.

Stand back wall

NB! Keep area under stand number and LCDs clear of logos and text.
Stand number sticker will be applied on-site.

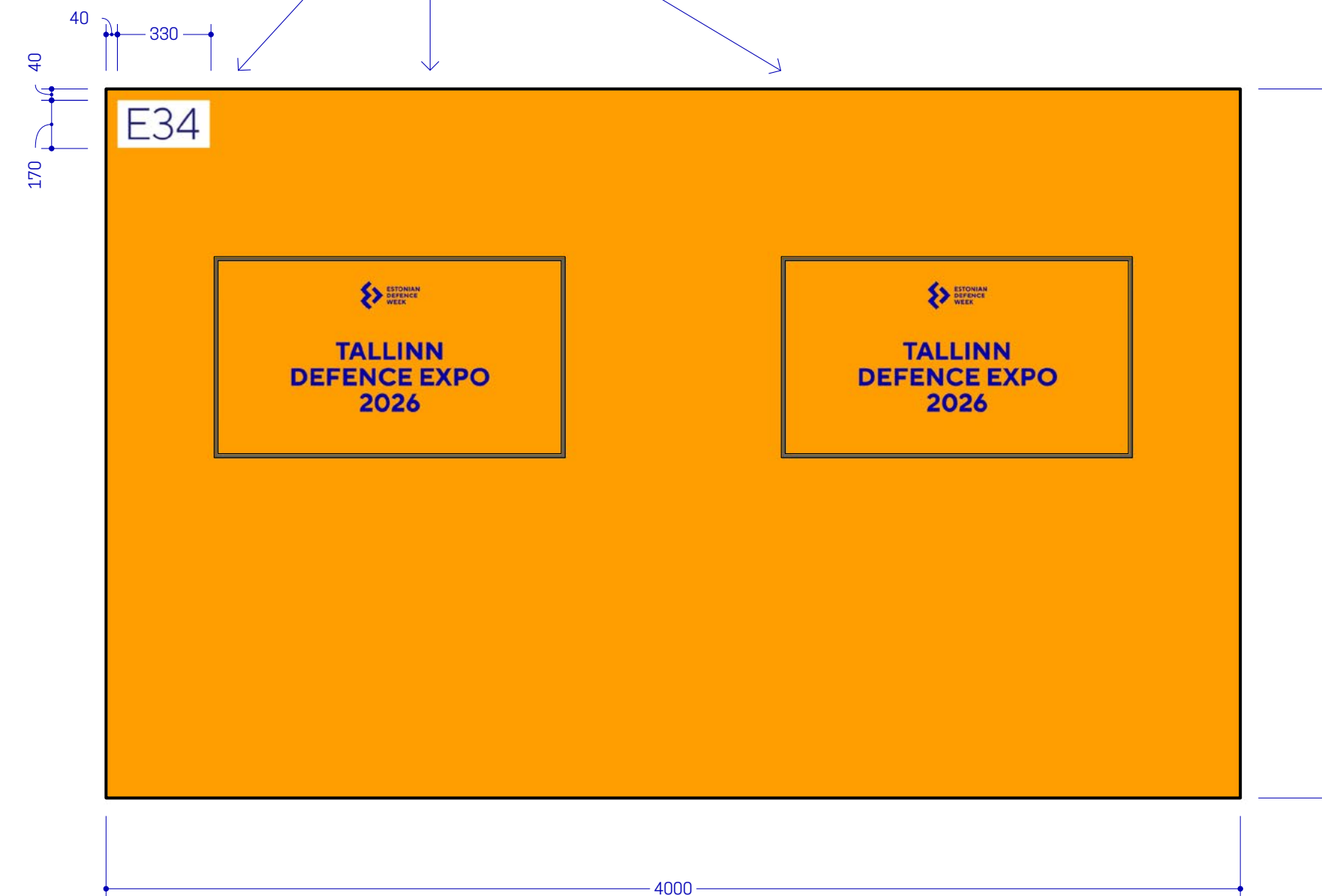

STANDS

STANDARD 1 CUSTOM DOUBLE

STANDARD 1 CUSTOM DOUBLE

All areas marked in orange can be customised with your own graphics.

55" LCD



Resolution
3840 x 2160 (16:9)

Set Dimension (WxHxD)
1238 x 709 mm

Active Display Area
1209.6 x 680.4 mm

Exhibition counter

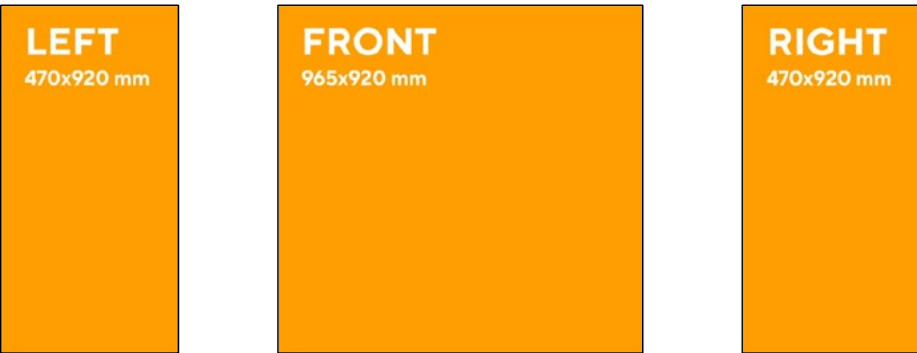

Exhibition counter 2

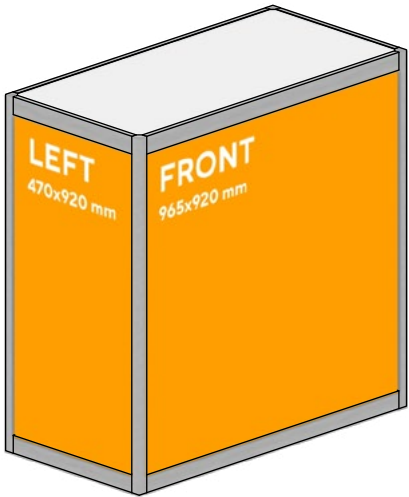

Important note:
All edges of the counter graphics will be inserted approximately 5–7 mm into grooves.
Avoid placing critical details or small text close to the edges.

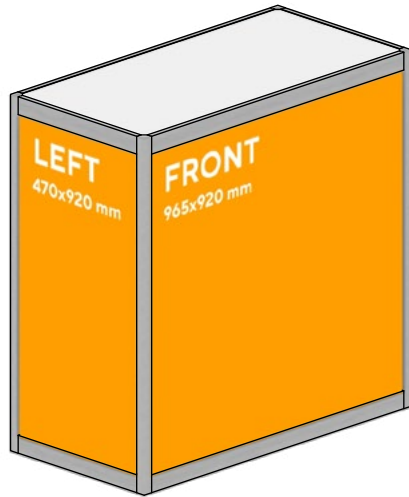

www.kingent.ee
A3 / M=1:20

STANDS

STANDARD 2 DOUBLE

- **Footprint:** 4.0 x 1.5 m
- **Height:** 2.3 m
- **Flooring:** Carpet with protective film
- **Power Supply:** 4 x Schuko sockets, 230 V, 16 A, 1.5 kW
- **Lighting:** LED ceiling lights, 300 lux, 4000 K
- **Exhibition counter:** 2 counters (1.0 x 0.5 m, height 1.0 m)
- **Seating:** 4 bar stools
- **Display:** 2 x 55" LCD screen with HDMI connection
- All areas marked in orange can be customised with your own graphics.

STANDARD 2 DOUBLE

All areas marked in orange can be customised with your own graphics.

Iso view



www.kingent.ee
A3/M=1:20

STANDS

STANDARD 2 DOUBLE

STANDARD 2 DOUBLE

All areas marked in orange can be customised with your own graphics.

Front view

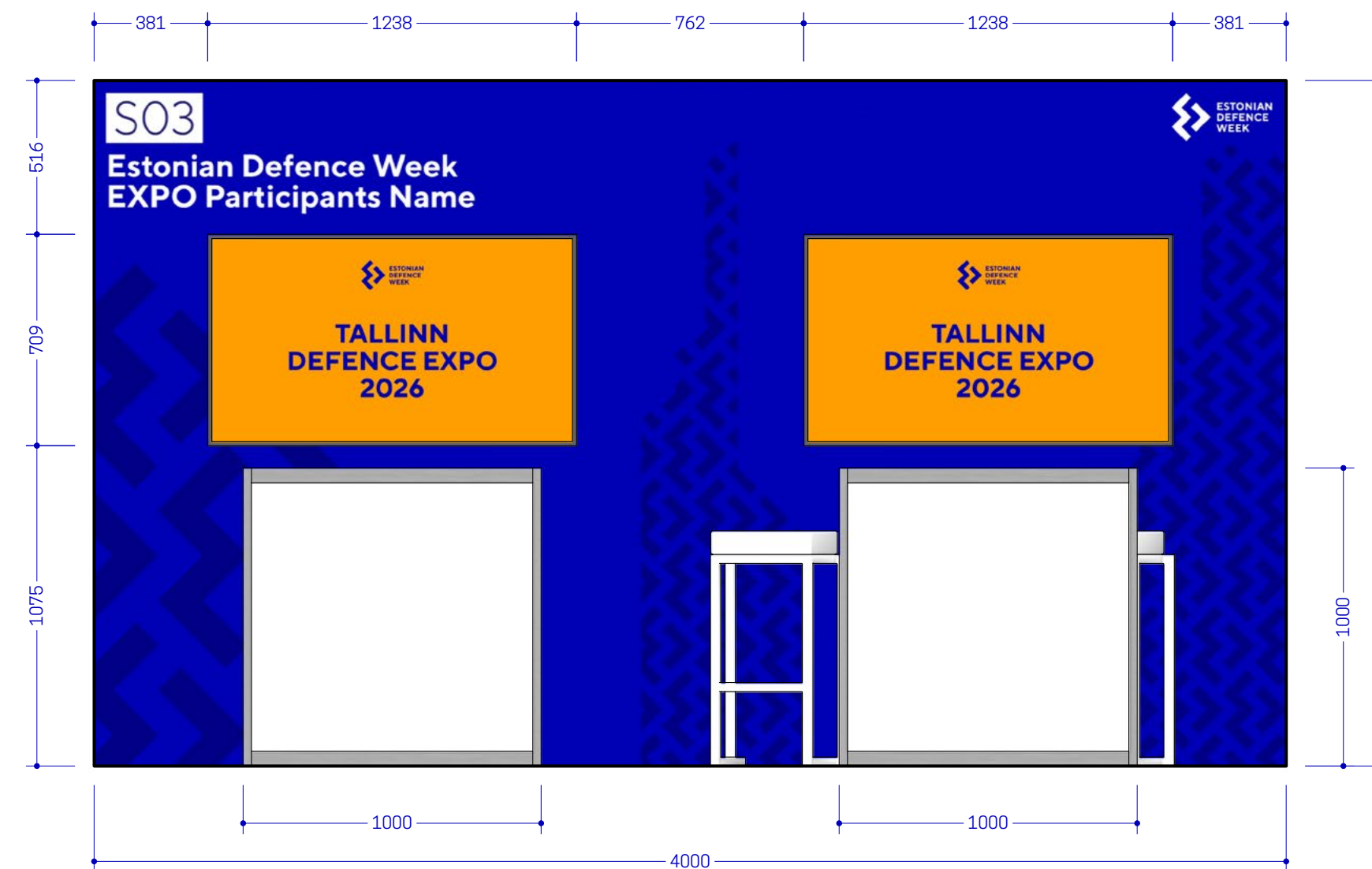

STANDS

STANDARD 2 CUSTOM DOUBLE

- **Footprint:** 4.0 x 1.5 m
- **Height:** 2.3 m
- **Flooring:** Carpet with protective film
- **Power Supply:** 4 x Schuko sockets, 230 V, 16 A, 1.5 kW
- **Lighting:** LED ceiling lights, 300 lux, 4000 K
- **Exhibition counter:** 2 counters (1.0 x 0.5 m, height 1.0 m)
- **Seating:** 4 bar stools
- **Display:** 2 x 55" LCD screen with HDMI connection

Custom graphic design option

Exhibitors may customise designated stand areas (marked in orange) with their graphics. All designs must meet event standards and require approval by the Expo Manager for consistency.

Important:

The deadline for submitting graphic design files is 12 June 2026.

STANDARD 2 CUSTOM DOUBLE

All areas marked in orange can be customised with your own graphics.

Iso view

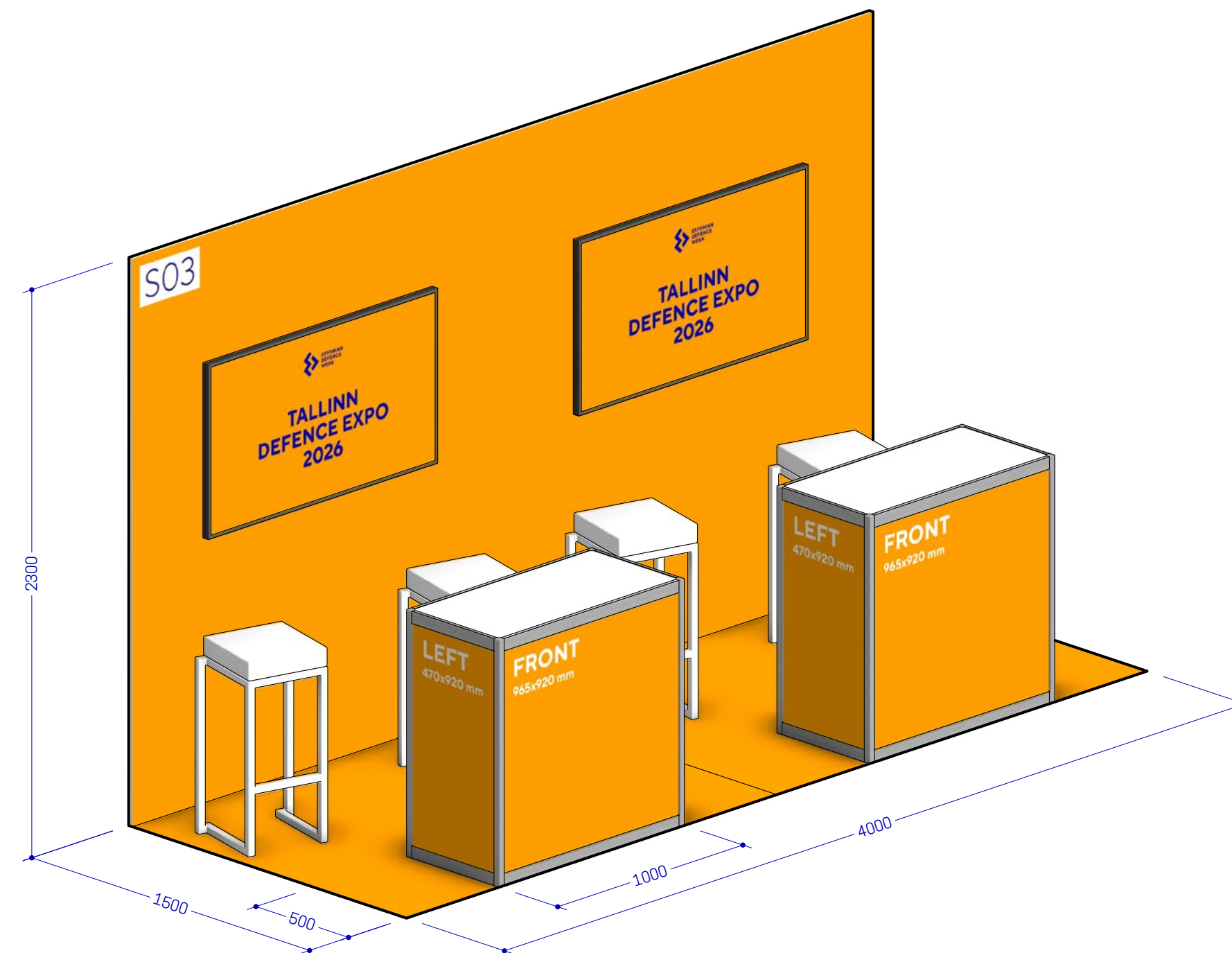

www.kingent.ee
A3 / M=1:20

STANDS

STANDARD 2 CUSTOM DOUBLE

STANDARD 2 CUSTOM DOUBLE

All areas marked in orange can be customised with your own graphics.

Front view

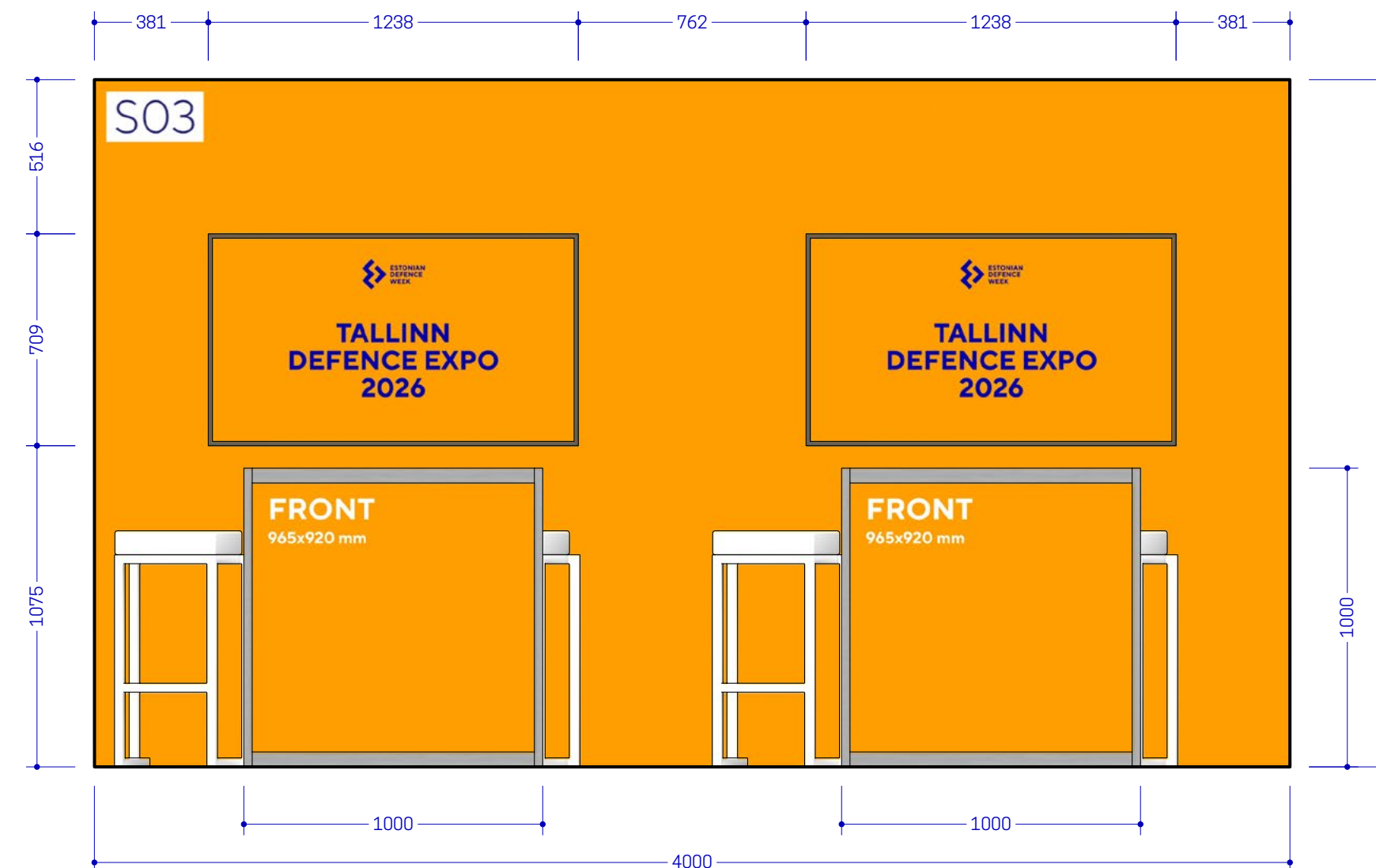

STANDS

STANDARD 2 CUSTOM DOUBLE

STANDARD 2 CUSTOM DOUBLE

All areas marked in orange can be customised with your own graphics.

Stand back wall

NB! Keep area under stand number and LCDs clear of logos and text.
Stand number sticker will be applied on-site.

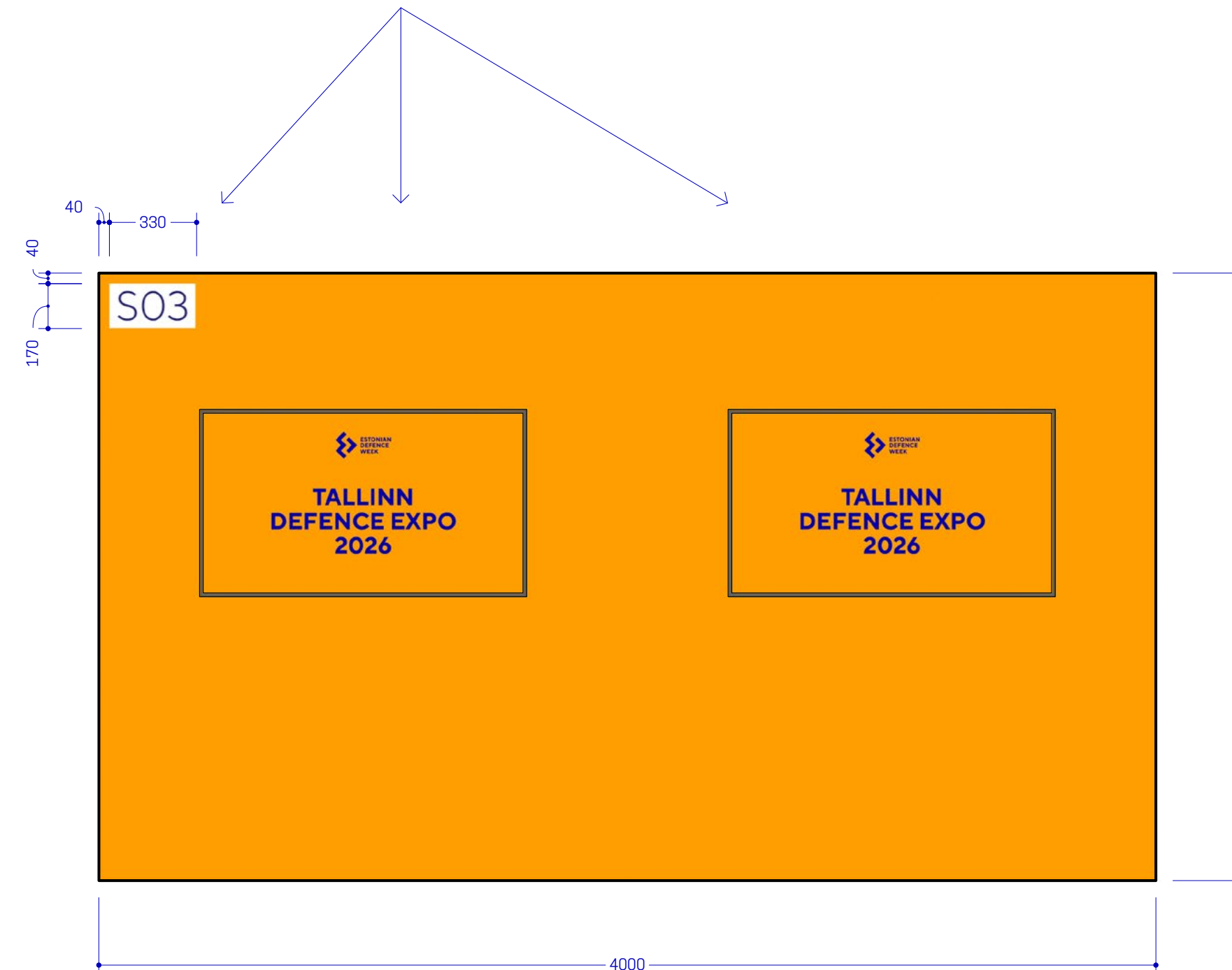

STANDS

STANDARD 2 CUSTOM DOUBLE

STANDARD 2 CUSTOM DOUBLE

All areas marked in orange can be customised with your own graphics.

55" LCD



Resolution
3840 x 2160 (16:9)

Set Dimension (WxHxD)
1238 x 709 mm

Active Display Area
1209.6 x 680.4 mm

Exhibition counter

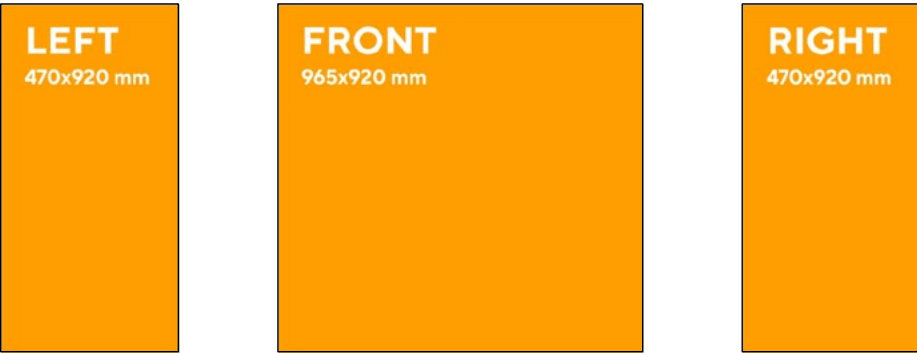

Exhibition counter 2

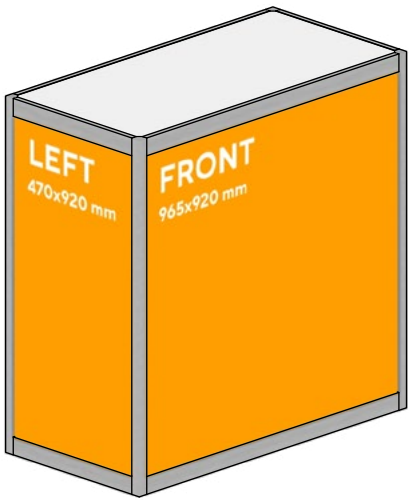

Important note:
All edges of the counter graphics will be inserted approximately 5–7 mm into grooves.
Avoid placing critical details or small text close to the edges.

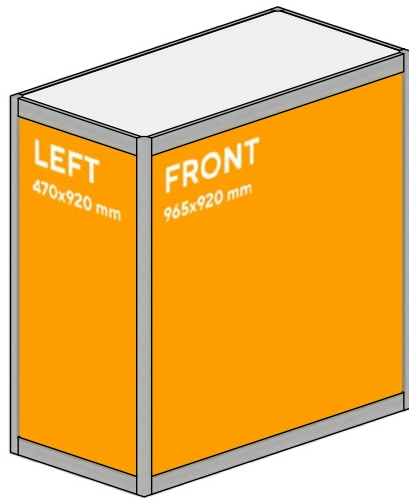

www.kingent.ee
A3 / M=1:20

STANDS

STANDARD OUTDOOR STAND

- **Footprint:** 3.0 x 6.0 m
- **Surface:** Tarmac
- Load restrictions apply – verification required
- Some stand areas are on sloped ground – check with your Expo Manager for details
- Restrictions may apply when ordering stand equipment for sloped areas
- Tents, levelled flooring, electrical supply, and other stand equipment are available upon request via the Expo Manager (additional cost)

The outdoor area is enclosed by a low fence and is **not accessible to the public**, but remains **visible from a distance**.

Overnight security is provided by the organisers.

CUSTOM GRAPHIC DESIGN

STANDARD 1 STAND

Graphic design for back wall

- Dimensions: 2000 mm (W) × 2500 mm (H)
- Important: centre area will be covered by a 55" LCD screen.
- Mandatory: stand number placed in the upper-left corner.

Graphic design for counter sides

- Front side: 965 mm (W) × 920 mm (H)
- Left and right sides (each): 470 mm (W) × 920 mm (H)

Important note:

All edges of the counter graphics will be inserted approximately 5–7 mm into grooves.
Avoid placing critical details or small text close to the edges.
(See reference on page 5.)

STANDARD 2 STAND

Graphic design for back wall

- Dimensions: 2000 mm (W) × 2300 mm (H)

PRINT SPECIFICATIONS

- File: Print-ready PDF (preset: “Press Quality” or “PDF/X-1a:2001”)
- Colours: CMYK
- Bleed: 10 mm on all sides
- Fonts: Outlined (converted to paths); no live fonts
- Images: 100–150 ppi at final (1:1) size; scale accordingly (e.g., 1:10 at 150 ppi = 1:1 at 15 ppi)

Note: Custom graphic designs for stands are available as an additional paid service. Please inquire with the EXPO team for details and pricing.

TALLINN DEFENCE EXPO 2026

LAYOUT PLAN TALLINN CREATIVE HUB

LEGEND

- Sponsors at the Outdoor Area and in the Atrium (S)
- Outdoor EXPO (F)
- EXPO Arena A in Cauldron Hall (01-40)
- EXPO Arena B in Small Hall (41-57)
- EXPO Arena C in Atrium Hall (58-74)
- Outdoor area fence

ARENA B (Level 0) Access Points:

1. Main path from Accreditation Center.
2. Via Small Hall balcony from the Atrium (Level 1).

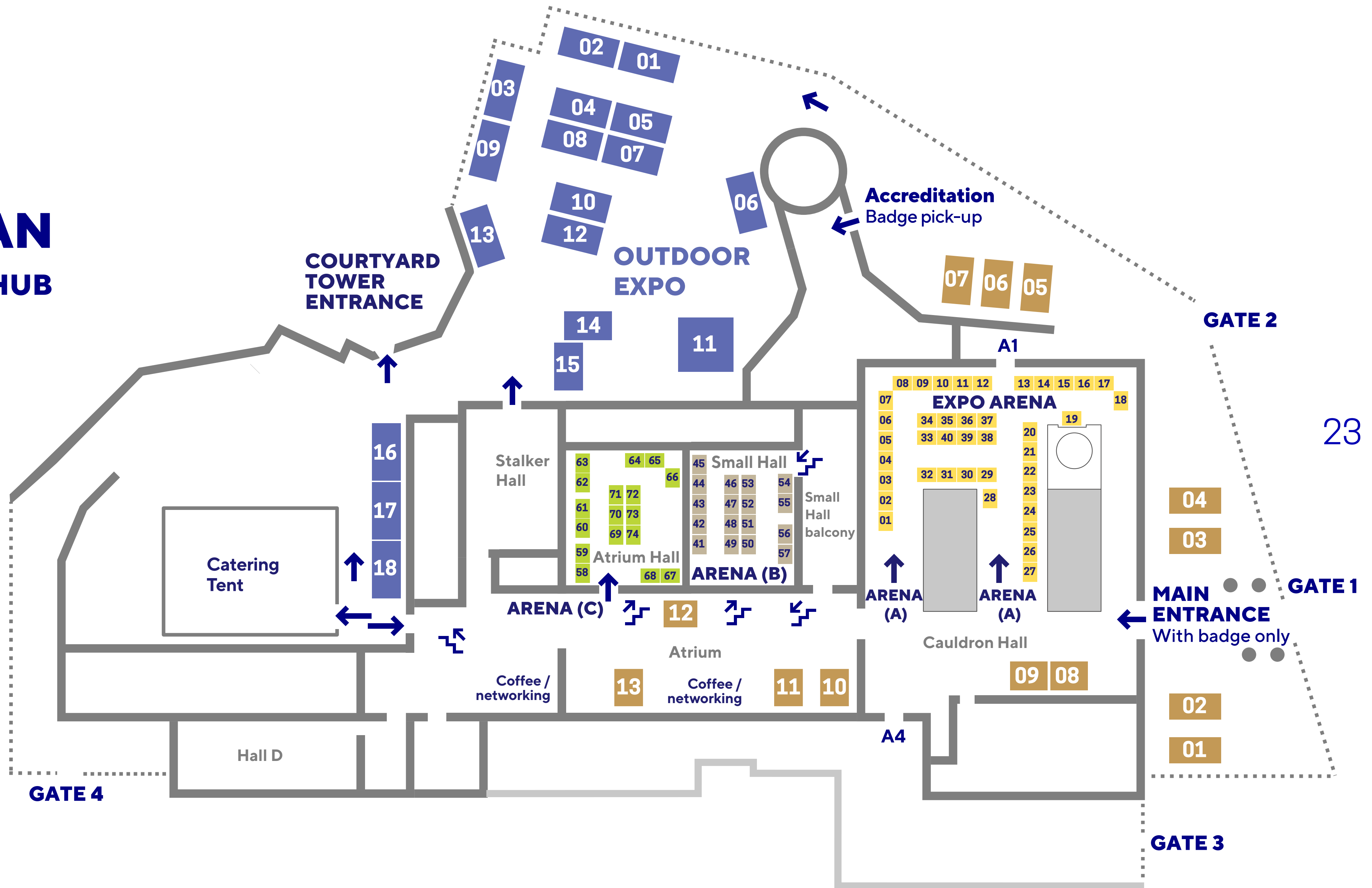

* Provisional layout - subject to change.

HOW TO GET HERE?

The Creative Hub is centrally located in Tallinn and easily accessible by various means of transport:

Walking

A short walk from Old Town, Viru Gate and the Port of Tallinn.

Public Transport

Conveniently connected by bus and tram. Both designated stops are just a short walk to the venue.

- Buses: 3, 21, 21B, 41, 41B, 66 (Alight at the “Linnahall” stop).
- Trams: 1, 2, 5 (Alight at either the “Linnahall” or “Suur Rannavärv” stop)

By Car

Taxis can easily reach the venue.
Paid parking is available at the nearby Tallinn City Hall parking area

By Air

The Creative Hub is 6.5 kilometres from the airport.

Parking:

- at Kultuurikatel:
<https://kultuurikatel.ee/en/tallinn-creative-hub/how-to-get-here/#parking>
- Parking is available around the venue at designated areas and is subject to local parking fees.
- Please check the signs on-site or refer to Tallinn’s public parking regulations for details.



DATES & VENUE

EXPO DAYS

- 21 September 2026
 - Exhibitors load-in
 - DEFENCE INNOVATION DAY 2026
- 22 September 2026
 - DEFENCE EXPO Day 1
 - SYMPOSIUM 2026
 - ABCD CONFERENCE 2026 Day 1
- 23 September 2026
 - DEFENCE EXPO Day 2
 - ABCD CONFERENCE 2026 Day 2
- 24 September 2026
 - DEFENCE EXPO Day 3
 - NATO Open Innovation Challenge (OIC) 2026
 - Exhibitors load-out

LOCATION

The Creative Hub (Kultuurikatel), Kursi tn 3, Tallinn 10415

Destination PIN: 59.44436155707877, 24.751323184951033

Google Maps Link: Event Venue (<https://maps.app.goo.gl/g9WNYLQK6sftyACS6>)

Parking: at Kultuurikatel (<https://kultuurikatel.ee/en/tallinn-creative-hub/how-to-get-here/#parking>)

Parking is available around the venue at designated areas and is subject to local parking fees.

Please check the signs on-site or refer to Tallinn's public parking regulations for details.

ADDITIONAL SERVICES

EDW EXPO provides additional technical and convenience services for exhibitors. The available services include but are not limited to:

- AV Equipment & Services
- Lighting Solutions
- Furniture, Staging, and Scenic Design
- Event Production
- Photography, Videography & Editing
- Graphic Design
- Support Personnel & Technical Crew
- Catering Services
- Courier Services
- Storage

For details, custom pricing, and to order additional services, contact your Expo Manager:

Primary Contact - Expo Manager:

Merlyn Paomets
merlyn@kingent.ee
+372 5840 0583

General Office & Backup:

Kingent Management
expo@kingent.ee
+372 5557 5318
www.kingent.ee